

NOISE DIFFUSER DF 15

DESCRIPTION

The DF15 all stainless steel noise diffuser spreads out the high velocity discharge from steam or air traps while dampening the level of noise associated with steam or compressed air trap cycles. Connections are female screwed.

MAIN FEATURES

A reduction of about 80% of noise can be expected measured at 1 metre from the application. Simple and compact design.

OPTIONS: Outlet without thread, suitable for direct discharge to atmosphere (DF16).

USE: Saturated steam and compressed air. On the discharge of steam or air traps, blowdown valves, air cylinders, etc.

AVAILABLE MODELS: DF15 and DF16.

SIZES: 3/8", 1/2" and 3/4".

CONNECTIONS: Female screwed ISO 7/1 Rp (BS21)

INSTALLATION: Horizontal or vertical installation. Before installing the diffuser, blow all dirt and scale from the system. Diffuser discharge must be oriented toward floor or other suitable enclosure.

CAUTION: Do not install diffuser in such a manner that may cause accidental exposure of discharge.

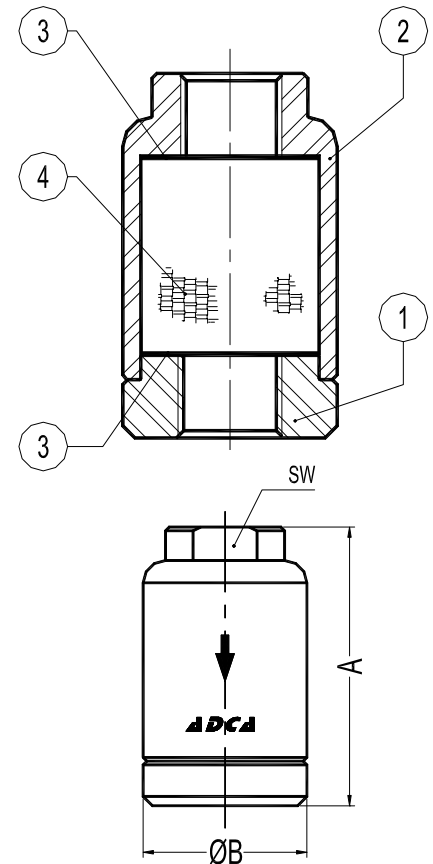

DIMENSIONS (mm)				
SIZE DN	A	B	SW	WGT. Kgs
1/2"	80	36	45	0,9
3/4"	80	36	45	0,9
1"	90	40	56	1,3

MATERIALS		
POS.	DESIGNATION	MATERIAL
1	Body	AISI304 / 1.4301
2	Cover	AISI304 / 1.4301
3	Strainer screen	AISI304 / 1.4301
4	Element	AISI304 / 1.4301

PMA – Max.allowable pressure 40 bar
 TMA – Max.allowable temperature 400 °C
 PMO – Max.operating pressure 32 bar
 TMO –Max. operating temperature 250 °C
 How to order: i.e. DF15 DN 1/2" BSP

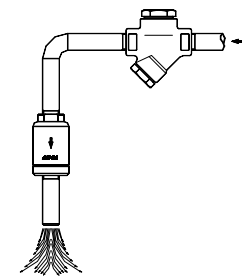

Application example (outlet of DT42S)